





-  **NO FASTENERS ALLOWED**
-  **BLUNT HEAD FASTENERS ONLY**
rivets, round head carriage bolts with threads inboard of sheet metal
-  **FASTENERS ALLOWED**
limit fastener protrusion beyond equipment to a minimum



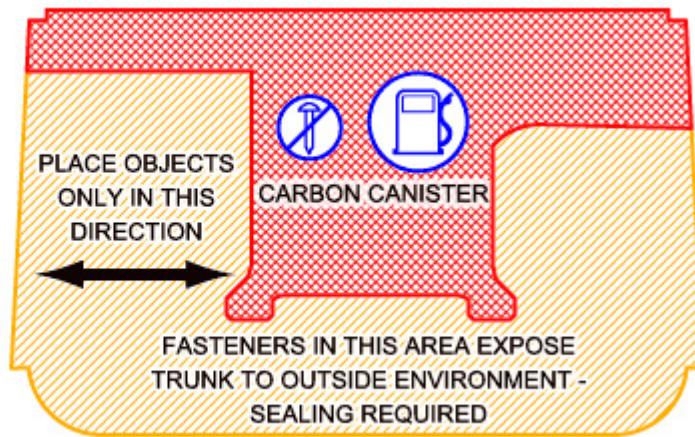

front of vehicle

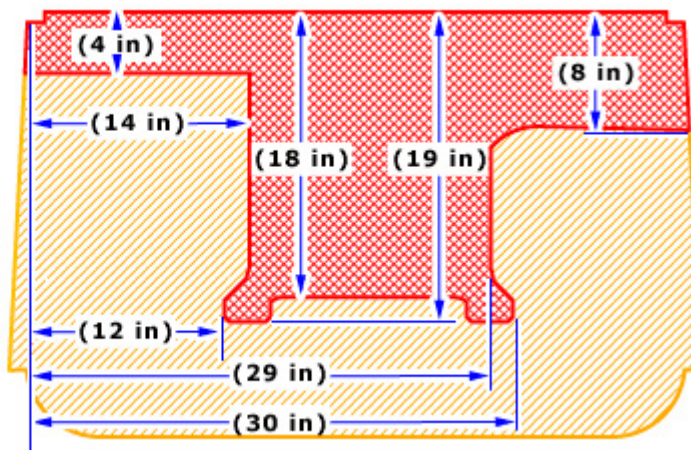
 rear of vehicle



front of vehicle

 rear of vehicle

-  **NO FASTENERS ALLOWED**
-  **BLUNT HEAD FASTENERS ONLY**
rivets, round head carriage bolts with threads inboard of sheet metal
-  **FASTENERS ALLOWED**
limit fastener protrusion beyond equipment to a minimum

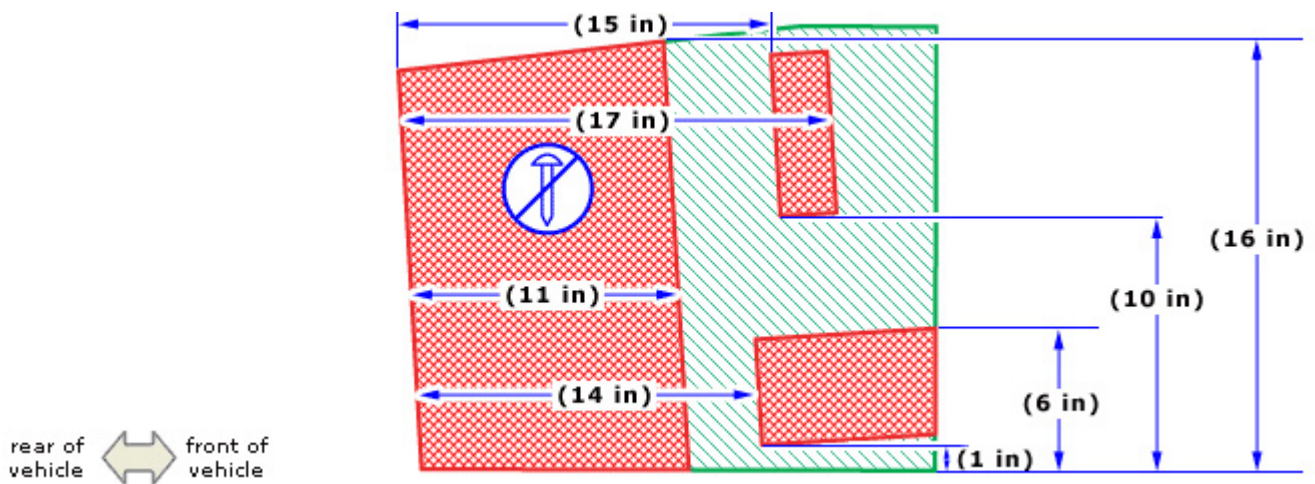
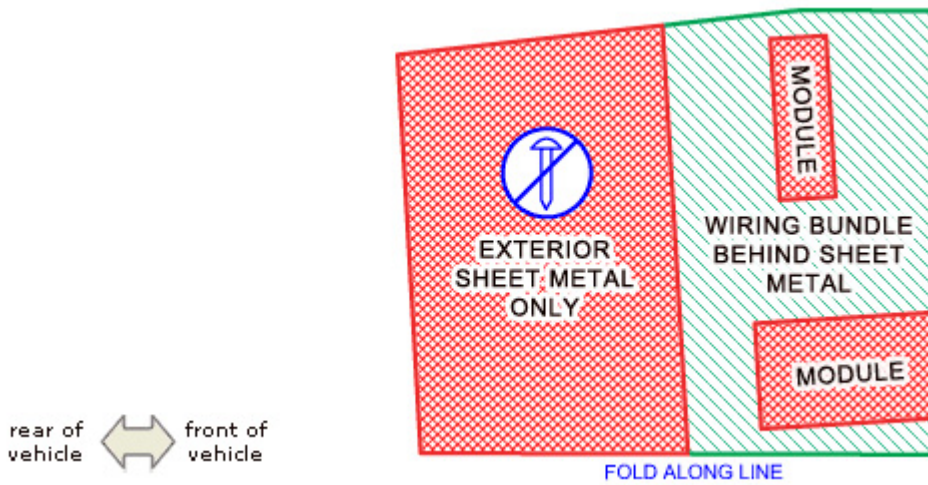



NO FASTENERS ALLOWED



BLUNT HEAD FASTENERS ONLY
rivets, round head carriage bolts with threads inboard of sheet metal



FASTENERS ALLOWED
limit fastener protrusion beyond equipment to a minimum



FOLD ALONG LINE

FOLD ALONG LINE

FASTENERS IN THIS AREA EXPOSE TRUNK TO OUTSIDE ENVIRONMENT - SEALING REQUIRED

FOLD ALONG LINE

FOLD ALONG LINE

rear of vehicle ↔ front of vehicle



NO FASTENERS ALLOWED



BLUNT HEAD FASTENERS ONLY
rivets, round head carriage bolts with threads inboard of sheet metal



FASTENERS ALLOWED
limit fastener protrusion beyond equipment to a minimum



FOLD ALONG LINE

FOLD ALONG LINE

FASTENERS IN THIS AREA EXPOSE TRUNK TO OUTSIDE ENVIRONMENT - SEALING REQUIRED

FOLD ALONG LINE

FOLD ALONG LINE

rear of vehicle ↔ front of vehicle

-  **NO FASTENERS ALLOWED**

-  **BLUNT HEAD FASTENERS ONLY**
rivets, round head carriage bolts with threads inboard of sheet metal

-  **FASTENERS ALLOWED**
limit fastener protrusion beyond equipment to a minimum

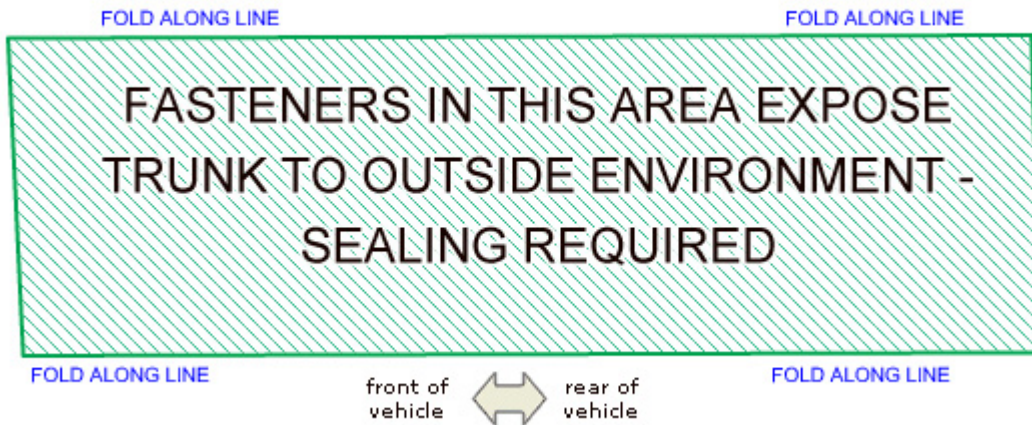



-  **NO FASTENERS ALLOWED**

-  **BLUNT HEAD FASTENERS ONLY**
rivets, round head carriage bolts with threads inboard of sheet metal

-  **FASTENERS ALLOWED**
limit fastener protrusion beyond equipment to a minimum



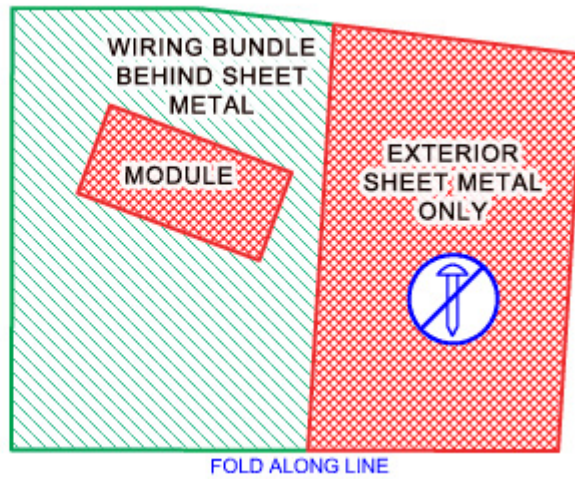

-  **NO FASTENERS ALLOWED**
-  **BLUNT HEAD FASTENERS ONLY**
rivets, round head carriage bolts with threads inboard of sheet metal
-  **FASTENERS ALLOWED**
limit fastener protrusion beyond equipment to a minimum

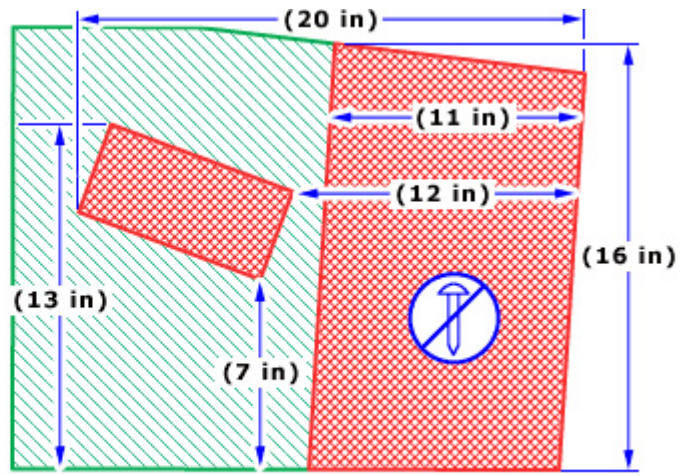

turn dimensions OFF



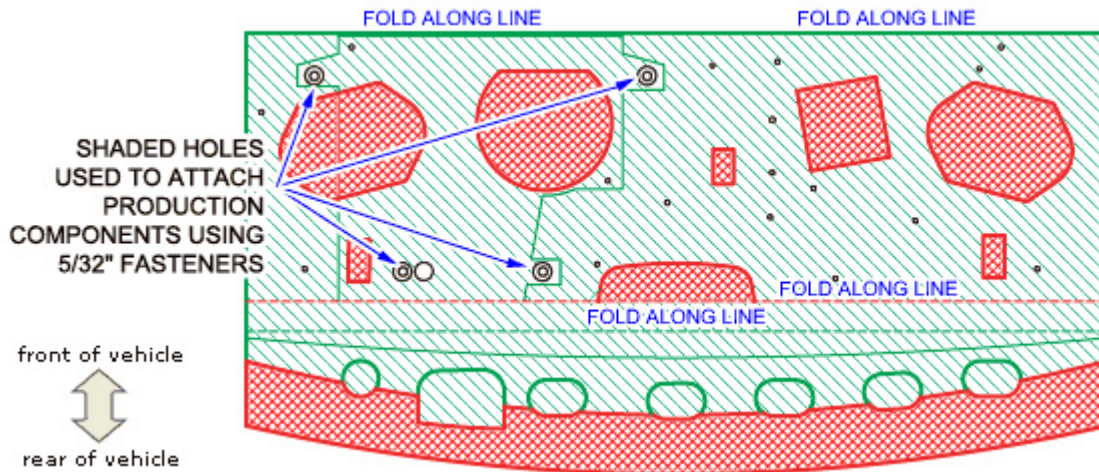

-  **NO FASTENERS ALLOWED**
-  **BLUNT HEAD FASTENERS ONLY**
rivets, round head carriage bolts with threads inboard of sheet metal
-  **FASTENERS ALLOWED**
limit fastener protrusion beyond equipment to a minimum

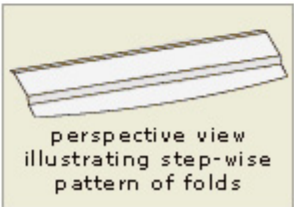

TOTAL WEIGHT OF EQUIPMENT MOUNTED UNDER PACKAGE TRAY MAY NOT EXCEED 14 LBS TOTAL





-  **NO FASTENERS ALLOWED**
-  **BLUNT HEAD FASTENERS ONLY**
rivets, round head carriage bolts with threads inboard of sheet metal
-  **FASTENERS ALLOWED**
limit fastener protrusion beyond equipment to a minimum

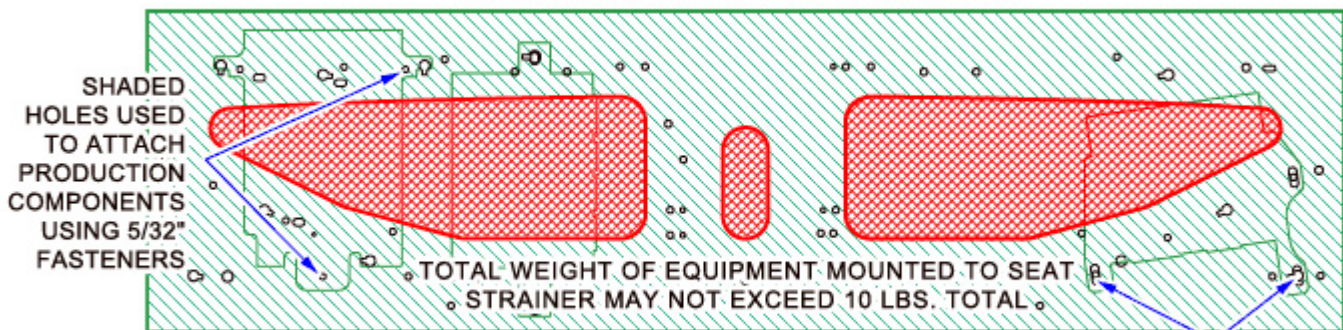

HOLES NOT USED FOR WIRING RETENSION - AVAILABLE FOR EQUIPMENT ATTACHMENT



SHADED HOLES USED TO ATTACH PRODUCTION COMPONENTS USING 5/32" FASTENERS

-  **NO FASTENERS ALLOWED**
-  **BLUNT HEAD FASTENERS ONLY**
rivets, round head carriage bolts with threads inboard of sheet metal
-  **FASTENERS ALLOWED**
limit fastener protrusion beyond equipment to a minimum

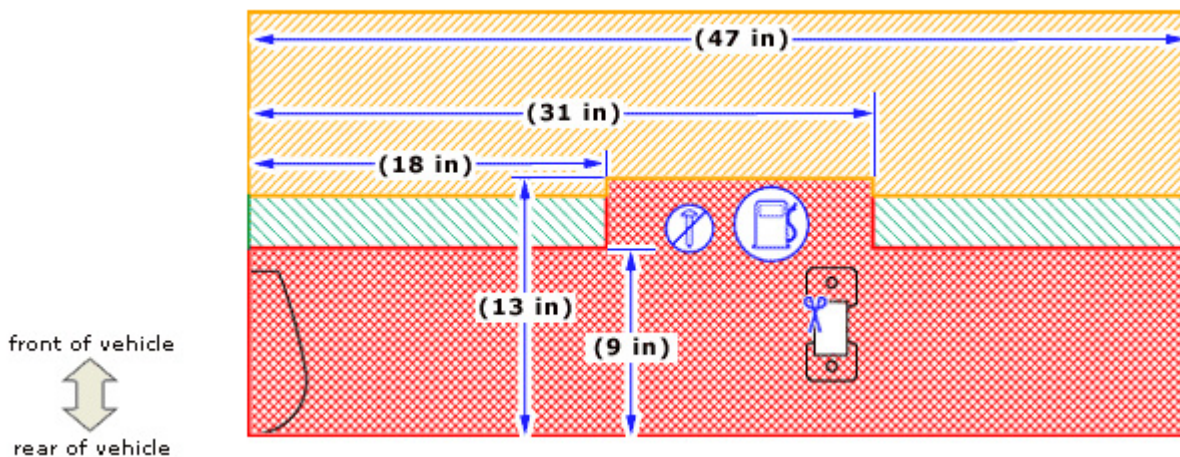
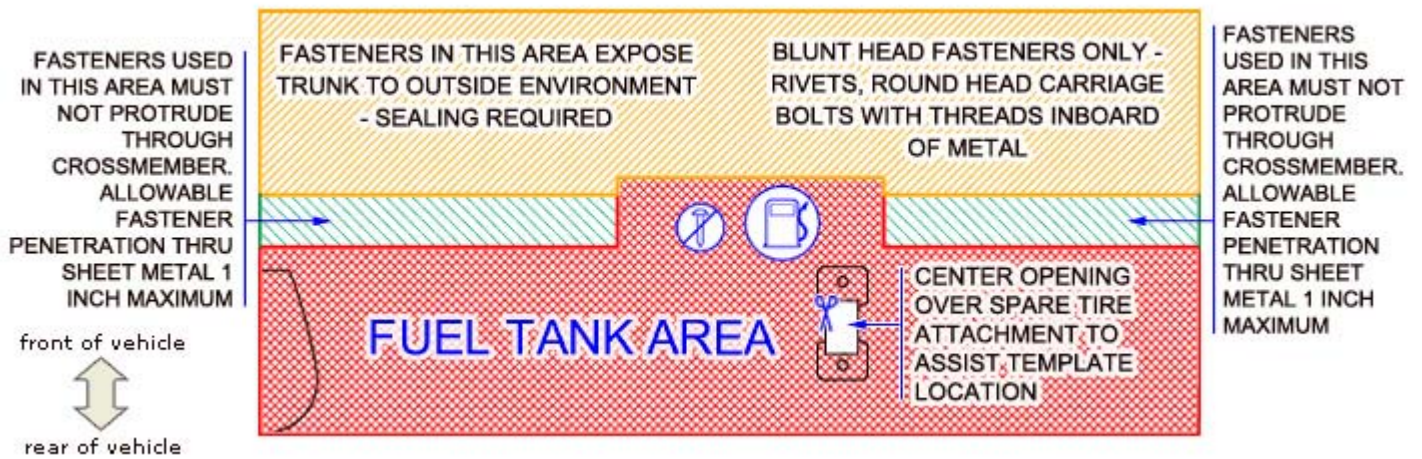



NO FASTENERS ALLOWED



BLUNT HEAD FASTENERS ONLY

rivets, round head carriage bolts with threads inboard of sheet metal



FASTENERS ALLOWED

limit fastener protrusion beyond equipment to a minimum



FOLD ALONG LINE

FOLD ALONG LINE



FOLD ALONG LINE

FOLD ALONG LINE